

# DRAGONFLY

## FIRENZA PLANCHA BBQ GRILLS USER MANUAL



## Dragonfly™ Plancha BBQ Grills

Thank you so much for buying a Dragonfly product. This manual contains setup instructions, warranty conditions, and additional information about your Dragonfly Plancha BBQ Grills.

### General information

Dragonfly cooking units are modular products consisting of various separate elements including a base, fire bowl, and cooking plate. All Dragonfly cooking units are shipped in special packaging units.

### Transport/packaging

The Dragonfly is shipped upside down. Our Dragonfly products are wrapped in an extra layer of packaging material to prevent damage during transport.

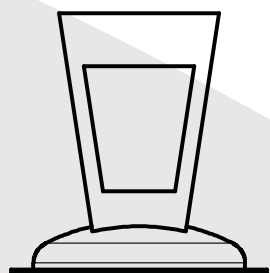

Dragonfly packaging



### Setup of your Dragonfly

The exterior of the box features an explanation regarding how to unpack your Dragonfly. Please note that all cooking units must be set up exactly as explained in these setup instructions! We are not liable for any damage resulting from incorrect setup attempts of Dragonfly cooking units.

### Base & Fire bowl

First, place the base on a fireproof surface. We recommend placing the base with two people, due to its considerable weight. Then, place the fire bowl in the base's hole so that it is level. If your surface is not entirely level, you can use the base's adjustable feet to make sure that it is level. Please note that if the adjustable feet are extended too far, the Dragonfly unit may become unstable. We recommend a maximum difference in level of 10mm. If the level difference exceeds 10mm, we recommend levelling the surface before setting up the Dragonfly Plancha BBQ Grill. Once the Dragonfly has been set up, it must not be shifted. Shifting it could cause damage to the adjustable feet and/or the rivet nuts with which the adjustable feet are attached. We do not accept warranty claims or liability for any damage resulting from shifting your Dragonfly cooking unit. Please note that the Dragonfly Black has a coating and is thus more sensitive to damage during setup. We are not liable for any damage or consequential damage resulting from the setup of your Dragonfly.

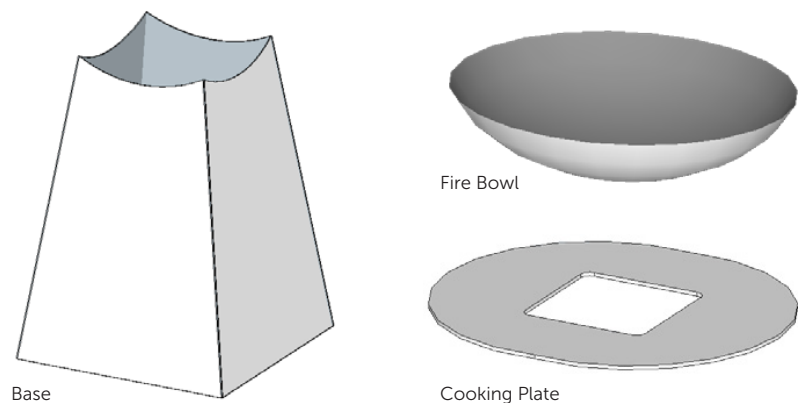

### Cooking plate

We recommend that you do not roll the cooking plate during transport; burs may form as a result, which prevent the cooking plate from being scraped down properly with a spatula. We recommend lifting the cooking plate with 2 people, due to its considerable weight. You can hold on to it using the thick outer edge as well as the inner edge. When placing the cooking plate onto the fire bowl, we recommend that 2 people hold the top's inner edge and position it over the fire bowl until it clicks into place. If the cooking plate does not fit the fire bowl so that it is level, you can turn it until its ring settles over the fire bowl.

**Please note:** we recommend the use of gloves when placing the cooking plate. Also, please be careful not to stain your clothes/fingers.

## Usage

### 1. Always outside

All Dragonfly Plancha BBQ Grills are made to stand outside in all weather conditions when used in conjunction with the appropriate rainproof cover. If your base is made of Corten steel, it will already show signs of corrosion when it arrives. The corrosion process may not yet have fully unfolded, meaning that the unit's colour will change over time as the corrosion process progresses. The natural layer of corrosion protects against rust perforation. Please note that for a few months after purchase - while your Corten model's corrosion process is still incomplete - running water may carry corroded material from the base and fire bowl to the surface the unit is standing on. This can lead to staining on light-toned surfaces. We are not liable for any damage resulting from this waste water. If you have purchased a black base for your Dragonfly, it's protective coating will prevent corrosion. It is important that you regularly treat the cooking plate with oil, both its surface and its rim. The cooking plate is made of steel and will corrode if oil is not baked into it. Once the oil has properly been baked in, only minor corrosion will develop. When the cooking plate is not used for longer periods, we recommend treating it with oil every 7-10 days to prevent corrosion.

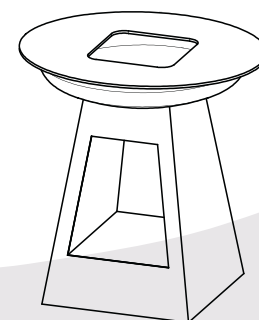

Dragonfly unit

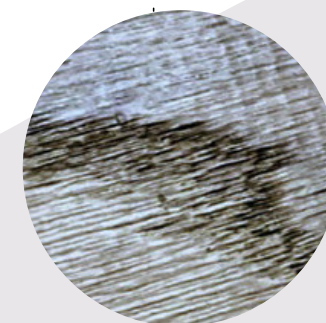

Excessive corrosion on cooking plate

Any corrosion that does develop can be removed using steel wool. In the event of excessive corrosion (see fig.), we recommend polishing its surface with a wire brush attached to a drill. It is best to heat the cooking plate before-hand, because that will loosen up the layer of corrosion. Once the cooking plate has been thoroughly polished, you will be able to wipe away the polishing residue with a cloth. Once you treat the cooking plate with oil, it will be good as new again. In order to properly protect your cooking plate from corrosion, you must also place an appropriate rainproof cover over your Dragonfly whenever it is left outdoors. To prevent the fire bowl from getting clogged, we recommend that you remove the ashes from the fire bowl after every use.

## 2. Wood

For optimum user comfort, we recommend using dry wood to prevent smoke formation during cooking. Moreover, kiln-dried wood is much easier to light. Stack the pieces of wood two by two, with the bark facing outwards to further prevent smoke formation. Kiln-dried beech wood is best, because it burns down to a mass of embers that heat up the cooking plate optimally. This mass of embers is easily shifted around if you want to direct the heat elsewhere. When you light the fire and add new wood to the fire, it will generally smoke for a bit until it catches fire properly.

## 3. Initial use

Upon initial use, it is important to light a smaller fire for roughly 30 minutes to allow the cooking plate to settle properly. During manufacture, the middle of the cooking plate was pressed down just slightly. When the cooking plate is heated, it will be pressed

down even further, and if you light too big a fire during your initial use of your Dragonfly, this may cause the cooking plate to be pressed down too far during future use. It is very important to prepare the cooking plate properly using the aforementioned process. In some cases, the cooking plate may instead bulge upwards in the middle and thus become convex. This means the steel is incorrectly stressed. If this happens, please contact your dealer. If you light a fire that is too big using wood that reaches very high temperatures, such as the kind of hardwood that is used in construction, this may cause the cooking plate to warp entirely. We do not accept warranty claims for any damage resulting from such incorrect usage. All Dragonfly cooking plates are treated with oil during manufacture for protection against corrosion. Once you have prepped the cooking plate properly using a small fire, you can start building a larger fire. Considering the fact that Dragonfly cooking plate tops are 10mm thick, it takes quite a sizeable fire to get them heated through properly. Once the cooking plate is well heated, drizzle on olive oil and spread it with a kitchen towel.



Do this 2-3 times. Then scrape down the cooking plate with a spatula and push the scrapings into the fire. Initially, the cooking plate will give off a black substance. Simply drizzle it with olive oil a few more times, spread out the oil, and scrape down the cooking plate. Once all you can manage to scrape off is beige scrapings, the cooking plate is clean and ready for use. Simply drizzle on olive oil once more and spread it out, and start cooking! We recommend using olive oil the first 2-3 times you use your Dragonfly. Olive oil has a lower combustion point, which will help the cooking plate get a nice brown-black hue. After the first few uses, you can start using oil types with higher combustion points, such as sunflower oil or groundnut oil. Baking the oil into the cooking plate also protects it from corrosion. However, if the cooking plate is not used for longer periods on end, the oil will dry out and the cooking plate will start corroding when the weather is humid. To prevent such corrosion from forming, please refer to page 5.

#### 4. Cooking

It will take between 25 to 45 minutes, depending on the weather conditions and the outside temperature, for the cooking plate to reach a temperature of around 300 °C on the inner edge and around 200 °C on the outer edge. Start by building a fire using the method mentioned on page 6. Once your initial fire's wood is burning properly, spread out the embers under the edges of the cooking plate and add new wood with the bark facing up. Repeat this process as needed, for as long as you require the cooking plate to remain hot. You will notice that it will take a lot more wood during autumn and winter to keep the cooking plate hot than during spring and summer. If there is a breeze, the cooking plate will be hottest where the wind leaves the Dragonfly cooking unit, i.e. in the direction of the wind.

You can compensate for this by pushing more hot embers into the opposite direction. Once the cooking plate is starting to heat up, you must first scrape it down using the spatula and then rub it with an oiled cloth. Once the cooking plate is hot enough for cooking, add some oil where you intend to place the food. Whenever the cooking plate starts to appear dry and matte, you will need to add extra oil, to ensure that the cooking plate is always sufficiently greased. You will need to add more oil when cooking fish and vegetables than when cooking fatty meats.

If any food residue is left behind on the cooking plate, simply push it into the fire using the spatula. Rub the cooking plate down with an oiled cloth frequently, and it will be spotless again. We recommend that you do not allow a thick layer of residue to build up, because it will be hard to remove. It is better to scrape down the cooking plate frequently. Once you get used to using your Dragonfly, this should become a habit. Once you are done cooking, clean the cooking plate one last time using the procedure outlined on page 8, and if it is still luke warm after that, rub it with oil once more. This ensures that it will be properly protected and ready for next time. If you use your Dragonfly Plancha BBQ Grill a lot, a smooth layer of carbon residue will build up on the griddle top, making it more comfortable to use. From time to time, this layer might come off here and there. When you spot it chipping in places, simply scrape off the chips using the spatula, and rub on new oil. The carbon residue layer will gradually renew itself this way.

## 5. Extinguishing the fire

The best way is to let the fire die out on its own. Please note that the ashes and the cooking plate can stay hot long after use.

## 6. Maintenance

Dragonfly Plancha BBQ Grills are relatively low-maintenance. As stated previously, corrosion may build up on your prepped cooking plate if you do not use your Dragonfly for an extended period of time, but such corrosion can easily be removed. If you do not prep your cooking plate properly, the corrosion may be extensive and you will need to use a wire brush to remove the corrosion, as explained on page 5.



## Disclaimers

### 1. Corrosion

If you have purchased a Corten Dragonfly unit, it will show signs of corrosion on delivery. Corten steel is a type of steel that corrodes very rapidly, and it is precisely this corrosion that protects it against rust perforation. If you allow nature to take its course, it will take 6-12 months for Corten steel elements to corrode, depending on their location and the humidity level. Unlike many manufacturers of Corten steel products, we provide buyers of our products with an additional service by making sure that the corrosion process has already started by the time our products are delivered. Depending on their location and the humidity level, it will take another 3-6 months for this superficial corrosion to turn into a proper layer of corrosion. Therefore, any Corten steel elements that are less corroded than others upon delivery are not eligible for replacement. They will corrode naturally over time under the influence of the weather. While the corrosion is still superficial, Corten steel elements may cause orange stains on clothes, skin, and the surface they stand on. When it rains, water may also run off these elements, which may permanently stain light-toned stone or wooden surfaces. Under normal circumstances, the Corten steel will gradually develop a smooth, dark brown layer of corrosion that will not chip. However, this layer may chip in locations near the sea or the shore due to the high levels of salinity in such locations. The chipping will not cause any damage, but the chipped corrosion must be removed to prevent corrosion from forming on the surface the Dragonfly is placed on. We do not accept liability for any damage resulting from the corrosion of our products.

## 2. Wooden rings

Dragonfly Plancha BBQ Grills fit an optional wooden ring support. Although we do offer a larger cover to protect these rings from occasional rainfall, humid weather may cause them to warp or crack. We therefore recommend that you store these rings in a dry place after each use. We do not recommend leaving them outside overnight, as changes in temperature and humidity can cause them damage. If sharp or heavy objects are used to exert great force on these surfaces, these will become irreparably damaged. We do not accept liability for any damage resulting from the incorrect use of wooden rings.

## 3. Adjustable feet on Dragonfly™ cooking units

Once your Dragonfly has been set up, the adjustable feet can be used to make them level. We do not recommend using these feet to adjust the overall height of our cooking units, because they may become unstable if the adjustable feet are extended by more than 10mm. We do not accept liability for any damage resulting from the improper use of adjustable feet. Once Dragonfly cooking units have been set up, they must not be shifted. Shifting them could cause damage to the adjustable feet or the rivet nuts with which the feet are attached. We do not accept warranty claims or liability for any damage resulting from shifting and/or moving Dragonfly Plancha BBQ Grills.

## 4. Do not use in closed-off spaces

Dragonfly cooking units are unsuitable for use in partially or entirely closed-off spaces. Such use may cause an excess of dangerous fumes that may result in carbon monoxide poisoning.

## 5. Do not use pure alcohol, petrol, or other Chemical substances

The use of pure alcohol, petrol, or other chemical substances when lighting fires is very dangerous and may affect the food on the cooking plate. We are not liable for any health issues resulting from using chemical substances when lighting your Dragonfly Plancha BBQ Grill. Moreover, please make sure that the area around your Dragonfly cooking unit is clear of any highly flammable materials.

## 6. Do not leave your Dragonfly™ unattended

Please note that you should never leave your Dragonfly cooking unit unattended. Keep children and pets away from the unit.



## Warning!

- The Dragonfly will become very hot!
- Do not use your Dragonfly in a confined and/or habitable space (e.g. houses, tents, caravans, motor homes, boats). Danger of carbon monoxide poisoning fatality.
- Keep children and pets away!
- Do not use spirit or petrol for lighting or re-lighting!
- Use only firelighters in compliance with **EN 1860-3/BS 7952:2001**



## FAQs

### 1. Transport/packaging of your Dragonfly™

#### How will your Dragonfly™ be delivered?

Your Dragonfly cooking unit will be delivered in a packaging unit. It will be shipped upside down.

#### What Will Be Delivered Along With Your Dragonfly™?

Your Dragonfly cooking unit will be delivered in a box and will consist of a base, fire bowl and a cooking plate.

### 2. Cooking unit general information

#### What are Dragonfly™ Plancha BBQ Grills made of?

A Dragonfly unit's cooking plate is made of steel. The base and fire bowl of the Corten models are made of Corten steel. The bases and fire bowl of the Black models are made of coated steel.

#### Is my Dragonfly™ portable?

Dragonfly models are delivered in three separate pieces and as such are easy to move. We recommend moving the cooking plate with two people.

#### Can I leave my Dragonfly™ outside?

Your Dragonfly can be left outside in all weather conditions. However, the cooking plate may start corroding over time if it is not oiled or properly covered. If you do not have a cover for your Dragonfly we recommend oiling the cooking plate every 7 to 10 days while it is not in use. As long as the bases and fire bowls of our Black models are not scratched, they will not corrode.

#### How do I clean my Dragonfly™?

If you are not using a cover, we recommend oiling your Dragonfly cooking plate once every 7 to 10 days, as aforementioned. After you use your Dragonfly, the leftover ashes must be removed to prevent the fire bowl's air vent from clogging. Please note that the ashes will stay hot for a very long time; therefore, make sure to only store leftover ashes in fireproof containers, such as zinc buckets. Once the ashes have cooled, they can be removed with a dustpan and brush and deposited into a regular waste bin.

### 3. Setup of your Dragonfly™

#### Will my Dragonfly™ show signs of corrosion upon delivery?

If you have purchased a Corten model, your Dragonfly's corrosion process will already have started upon delivery. As the unit stands outside, the corrosion process will continue. Black units should show no signs of corrosion upon delivery.

#### Why does the cooking plate feel sticky?

The cooking plate was oiled before transport to protect it against corrosion forming.

#### Do I need to place anything underneath my Dragonfly™ to protect the surface it stands on from damage?

The bottom of the base is not likely to heat up enough during average use to damage your surface. However water may run down Corten Dragonfly units and cause stains on light-toned surfaces. To prevent stains, you can place a large flat stone or slab beneath your Dragonfly.



## FAQs continued

### How do I prepare my Dragonfly™ for its initial use?

Use the method described on pages 6-7. Once the cooking plate has been prepped, your Dragonfly Plancha BBQ Grill will be ready for its first cooking session. The food will stick to the cooking plate a little more at the beginning than after 2-3 uses. Similar to an old-fashioned cast-iron frying pan, a natural non-stick coating will develop over time.

### Can Dragonfly™ products be moved with their adjustable Feet in position?

No, they cannot, because the weight of the Dragonfly may cause the adjustable feet to bend or break and may damage the rivet nuts with which the adjustable feet are attached.

### Can the adjustable feet on Dragonfly™ products be used to adjust the height level of the products considerably?

No, the adjustable feet are solely intended to ensure that Dragonfly Plancha BBQ Grills can be made level when placed on uneven surfaces. The feet should not be extended by more than 10mm, because Dragonfly may then become unstable and the feet may bend or break.

## 4. Usage

### How do I light my Dragonfly™

When you light your Dragonfly for the first time using the method described on page 6, it is important that you let a low fire burn in it for 25 minutes first, to allow the cooking plate to settle properly.

### How long will it take for the Dragonfly™ to be ready for cooking?

Once the Dragonfly Plancha BBQ Grill has been lit, it will take between 25 to 45 minutes, depending on the weather conditions and the temperature outside, for the cooking plate to reach around 300 °C on the inner edge and around 200 °C on the outer edge.

### Which type of oil should I use?

The first few times you light your Dragonfly, we recommend using olive oil. Olive oil has a lower combustion point, which will help the cooking plate get a nice brown-black hue. After the first few uses, you can start using natural oil types like sunflower oil and groundnut oil, which have higher combustion points.

### How many people can I cook for on my Dragonfly™?

You can cook for 20 to 30 people on your Dragonfly unit.

### What type of wood should I use?

You can use a variety of wood types in your Dragonfly, but kiln-dried beech produces the best results. It burns down to a mass of embers that are easily spread around, and provide heat for an extended period. Ash wood has similar qualities. Oak is inferior, because it produces a thinner type of ash. Birch wood tends to burn up too quickly.

### Can I use charcoal instead of wood?

Yes, you can use charcoal as fuel for your Dragonfly. However, charcoal might not reach the same temperatures as fire wood.

## FAQs continued

### There are chips on my cooking plate; does that mean the steel is damaged?

Cooking on your Dragonfly regularly will cause a layer of carbon residue to build up on the cooking plate. This layer might come off in some places when the Dragonfly is not used for a while, resulting in chips forming. These chips can be scraped off using a spatula. Then, just rub on a new layer of oil; a smooth carbon residue layer will gradually build up again.

### My cooking plate became convex during the initial use, so now the fat runs off at the outside edge. What should I do?

During manufacturing, Dragonfly cooking plates were pressed down slightly in the middle, and they are further pressed down slightly when first heated. In very rare cases, the cooking plate may bulge upwards and become convex. If this happens, please contact your dealer.

## 1 year warranty

A one year warranty applies to the material and construction of all steel elements of Dragonfly Plancha BBQ Grills, provided the unit was purchased from an authorised dealer. This warranty is void for damage resulting from the improper use of your Dragonfly product - see the disclaimers on pages 11 to 13. **To make a warranty claim, you must retain your receipt as proof of your purchase.**



## Dragonfly™ Grill

### Grill

The Dragonfly grill is a robust accessory that can be used for various types of cooking, combined with a pan or on its own. When using the grill, your food may burn if the flames get too high. We are not liable for any health issues resulting from eating burned food prepared on our grill. The grill must be cleaned and oiled after every use. We are not liable for any corrosion forming on the grill. Please note that you should place the grill and its holder over the hole in the cooking plate before you start cooking. While you are cooking, the grill will become very hot. For this reason, you should only ever remove the grill from the griddle top wearing heatproof gloves.

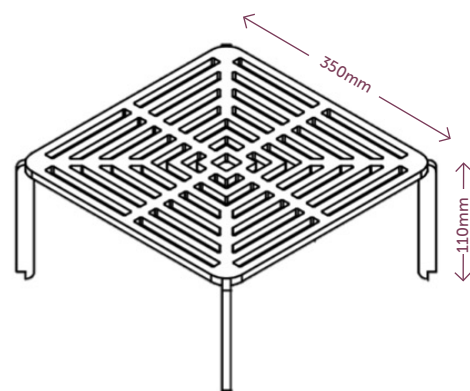

Dragonfly grill



### Dont's

Please note that the optional Dragonfly grills should never be moved during use!

The grill can reach temperatures of approximately 300 °C and thus are not suitable to be moved during or right after cooking without using heat-resistant gloves. We are not liable for any burn injuries resulting from touching the grills during or after cooking.

**Do not use our grills indoors.**





**Contact details:**

 [yourdragonfly.com](https://yourdragonfly.com)

 [support@yourdragonfly.com](mailto:support@yourdragonfly.com)

PM2031.1.9.22